

BD132B/BD132BT: Bidirectional Detector for R22 Waveguide

General Description

BD132B and BD132BT (Fig. 1 left) are bidirectional detectors with DC amplifiers that are intended for simultaneous sampling of the incident and reflected waves in high-power 2.45 GHz industrial applications using the R22 (WR430) rectangular waveguide. These detectors combine the following components:

- Four-port directional coupler
- Attenuators
- Zero-bias Schottky diode detectors
- Low noise operational amplifiers
- Temperature sensor with analog output (BD132BT only)

The detectors deliver two DC voltages in the range 0 to around 9 V, approximately proportional to the power of waves propagating in the forward and reverse directions in the parent waveguide.

The detector transfer curves are generally nonlinear and vary with temperature. A transfer curve of an “average detector” is presented in this datasheet.

Users can apply the output from the temperature sensor to their own software correction of the temperature dependence of the detector outputs.

The detector module is fastened to a parent waveguide by means of six M3 or similar-diameter screws after machining of appropriate holes in the waveguide wall. As an option, an assembly consisting of the module affixed to a precisely machined parent waveguide with the standard length 148 mm can be provided (Fig. 1 right).

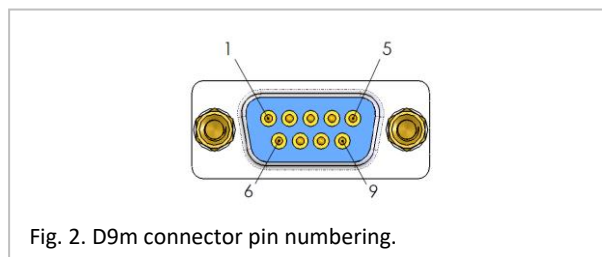

Fig. 1. Left: Bidirectional detector BD132B. Right: BD132B installed on a standard-length waveguide.

Specifications

Waveguide of destination	R22 (WR430)
Waveguide wall thickness	2 mm
Waveguide surface flatness required at BD interface	0.04 mm
Frequency range	2425 – 2475 MHz
Peak working power	1 kW, 10 kW, 30 kW
Directivity	25 dB min
Output voltage polarity	Positive
Internal time constant	0.15 ms
Statistical spread of output voltage	± 1 dB (3- σ deviation)
Output voltage temperature variation (+5 °C to +65 °C)	< 3 dB
Output voltage offset	± 5 mV max
Offset temperature variation (-10 °C to +65 °C)	5 mV max
Power supply voltage	24 V $\pm 10\%$ DC
Power consumption	< 1 W (40 mA @ 24 V)
Connector	D-sub 9-pin male (D9m)
Dimensions (L x W x H)	73 mm \times 73 mm \times 29.5 mm
Mass	220 g
Operating temperature range	-10 °C to +65 °C
Storage temperature range	-20 °C to +80 °C

Pin Assignment



Pin	Signal	Description
1	RFL	Reverse (reflected) signal: detector output
2		
3		
4	TSENS	Temperature sensor output
5	VNEG	Negative DC power supply input (0 V)
6	FWD	Forward (incident) signal: detector output
7		
8	GND	Signal ground. Negative DC power supply input (0 V)
9	VPOS	Positive DC power supply input (+24 V)

Notes:

- RFL, FWD and TSENS outputs are referred to GND.
- The forward wave should propagate in the direction of the arrow on the nameplate.
- Unassigned pins are not connected.
- TSENS is available only in BD132BT.

Detector Correction Curve

A detector correction curve is the inverse of the transfer curve $V = f(P)$ where P is the power of a wave propagating in the waveguide in a given direction and V is the output voltage of the corresponding channel. The correction curve can serve, in particular in its mathematical form, for determining the input power from the output voltage. Fig. 3 shows a typical *normalized* correction curve for an ambient temperature of $T_a = 25\text{ }^\circ\text{C}$ and frequency 2450 MHz, where P_{\max} is the specified maximum working power. The typical output voltage for the maximum working power P_{\max} is lower than the theoretically possible 10 V to accommodate the temperature dependence and statistical variations.

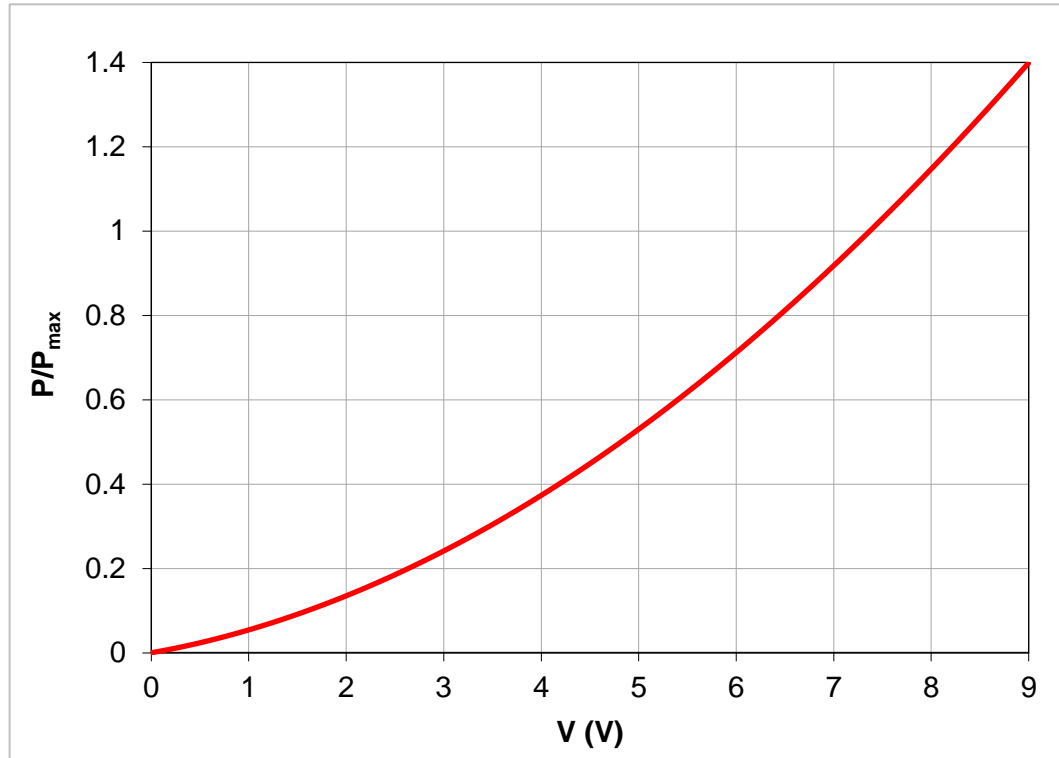

Fig. 3. Typical BD132B correction curve for both directions. P_{\max} is the specified maximum working power.

The curve can be approximated by the polynomial

$$P / P_{\max} = d_1 V + d_2 V^2 + d_3 V^3 + d_4 V^4 + d_5 V^5 + d_6 V^6$$

where P is the input microwave power, P_{\max} is the specified maximum working power (both in the same units), V is the output voltage in millivolts, and d_i are the coefficients listed in Tab. 1. There is an ample reserve enabling working with powers exceeding P_{\max} .

Tab. 1. Polynomial coefficients for BD132B correction curve.

Coefficient	Value
d_1	4.0236020E-02
d_2	1.4546473E-02
d_3	-6.5292208E-04
d_4	1.2399803E-04
d_5	-1.1846439E-05
d_6	4.1549405E-07

Please be aware that the function is a statistical average based on evaluation of a number of detectors. The behavior of individual detectors may vary. For more critical applications that require accurate and temperature-independent power measurement, we recommend the use of the bidirectional power meter BPM132 instead.

Typical Directivity

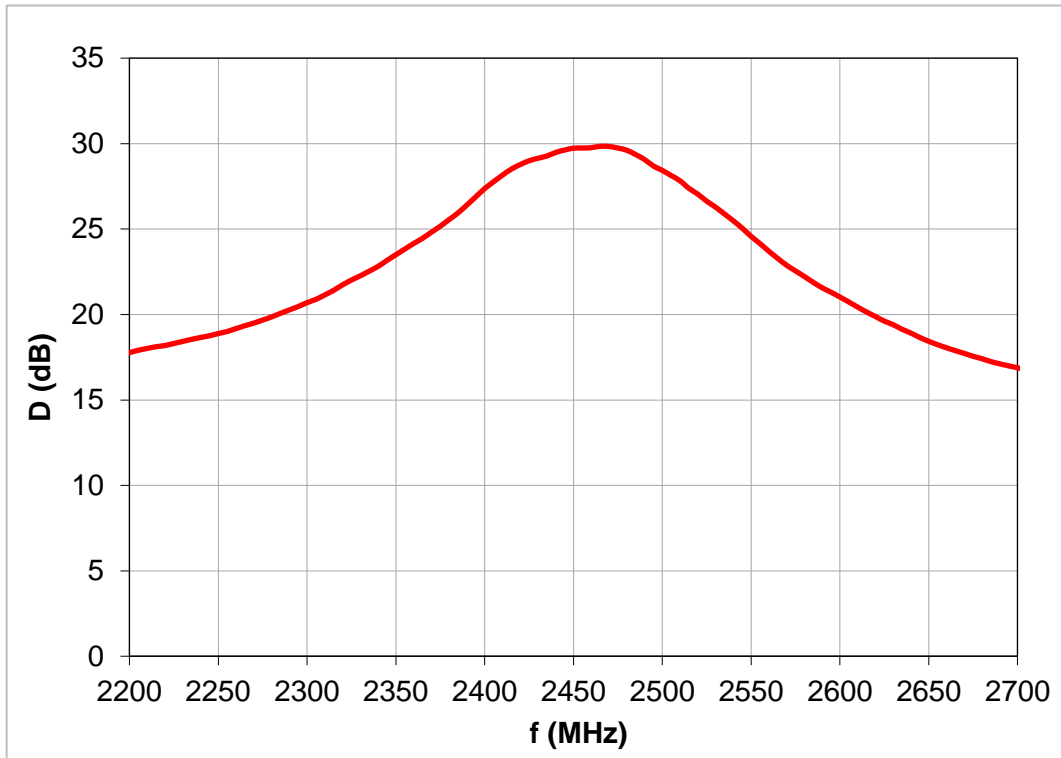

Fig. 4. Typical BD132B directivity (both directions).

Dimensional Drawing

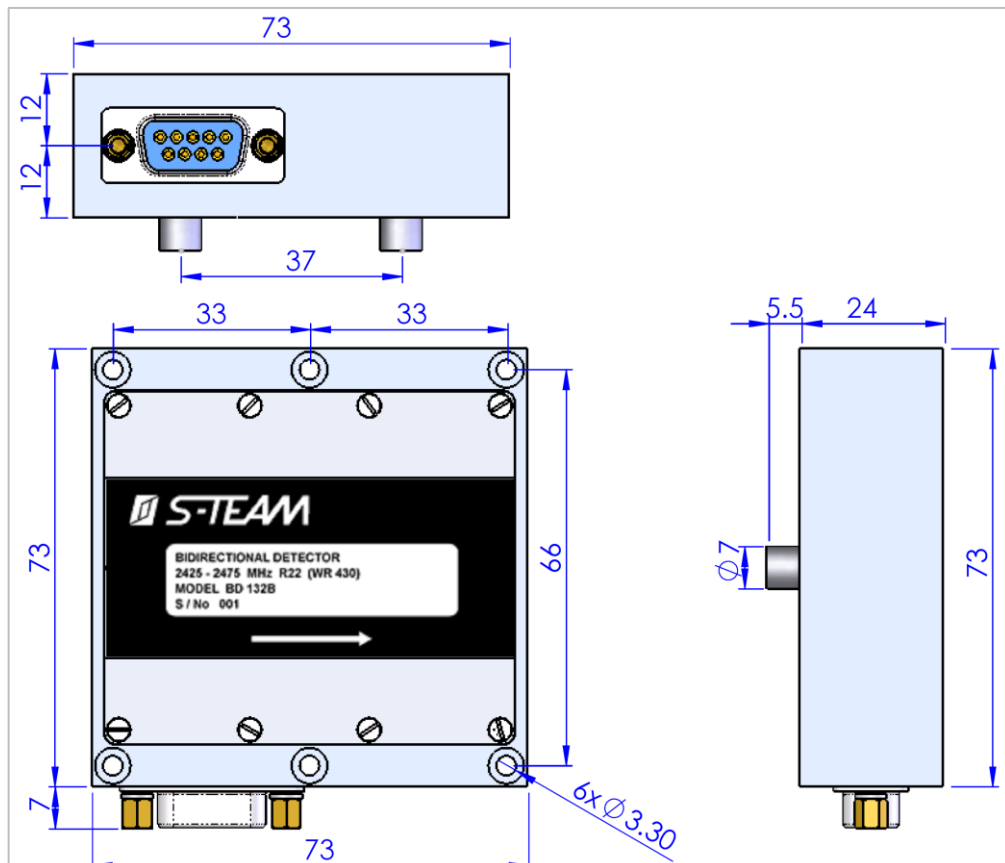

Fig. 5. Basic BD132B dimensions. All dimensions are in millimeters.

Waveguide Machining Template

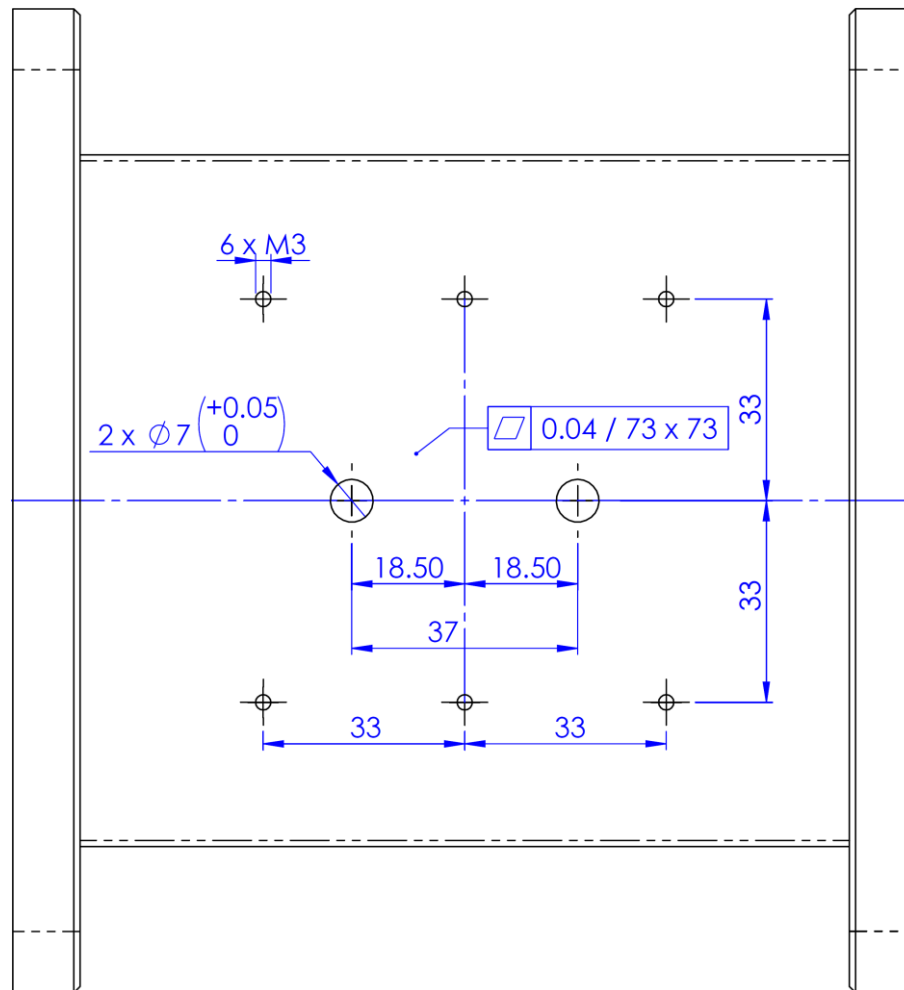

Fig. 6. Waveguide machining template. All dimensions are in millimeters. The waveguide wall thickness must be 2 mm.

Important Note

Complying with the specified waveguide wall thickness and flatness of its surface interfacing with the detector is essential in order to achieve the specified measurement accuracy. The slope of the coupling factor as a function of the wall thickness is about -6 dB/mm (i.e., increasing the wall thickness decreases the output power readings).

If the wall thickness differs from the specified figure but is known, one can apply a user-defined correction based on the above slope. Nevertheless, the wall thickness should not deviate from the specification by more than ± 0.3 mm, as otherwise BD directivity will deteriorate.

To avoid problems with manufacturing precision waveguide components, one can order a calibrated assembly consisting of a BD module fixed to a parent waveguide. The standard waveguide length is 148 mm.

Output Schematic Diagram

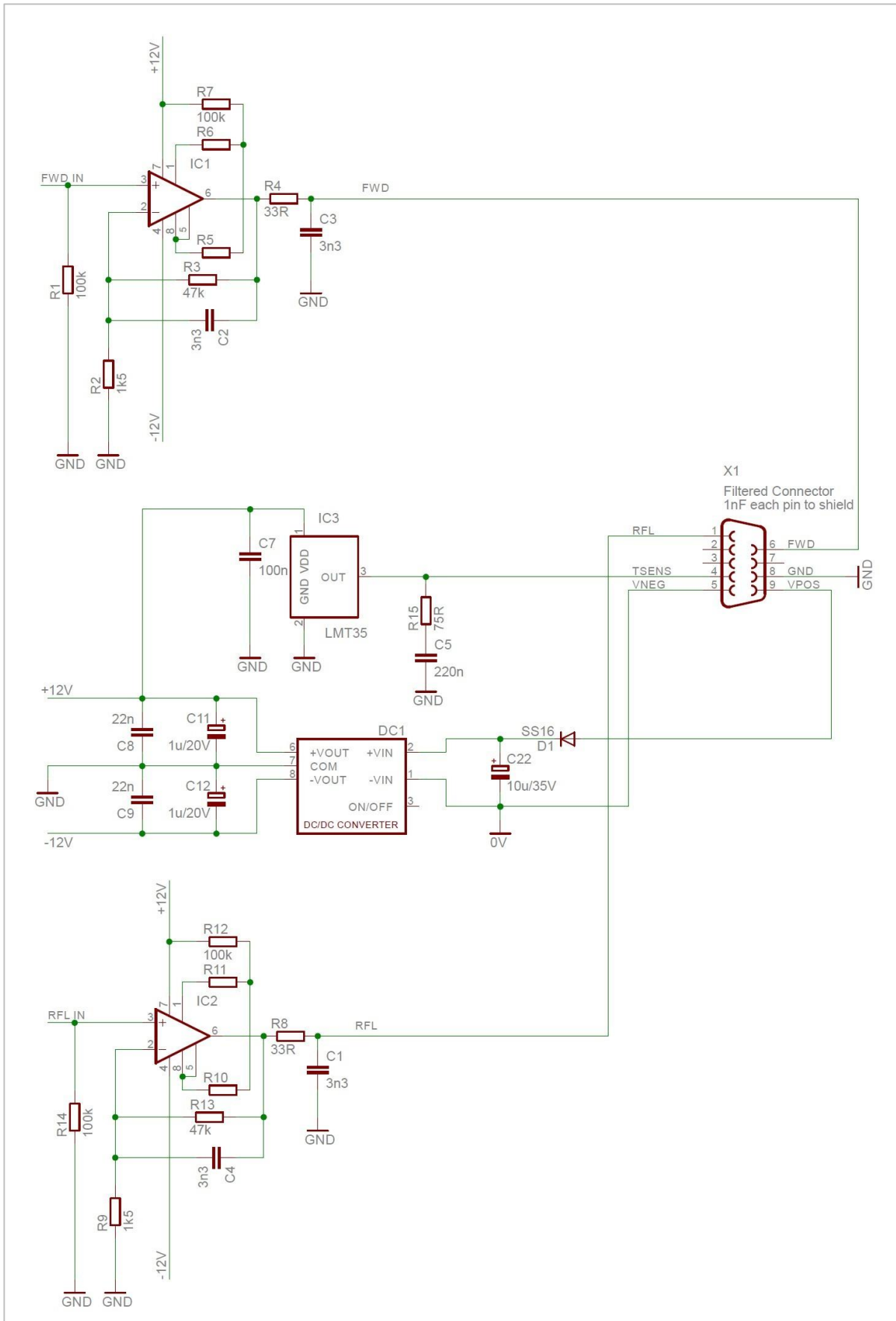

Fig. 7. Output schematic diagram of bidirectional detectors with amplifiers and temperature sensor.

Wiring Examples

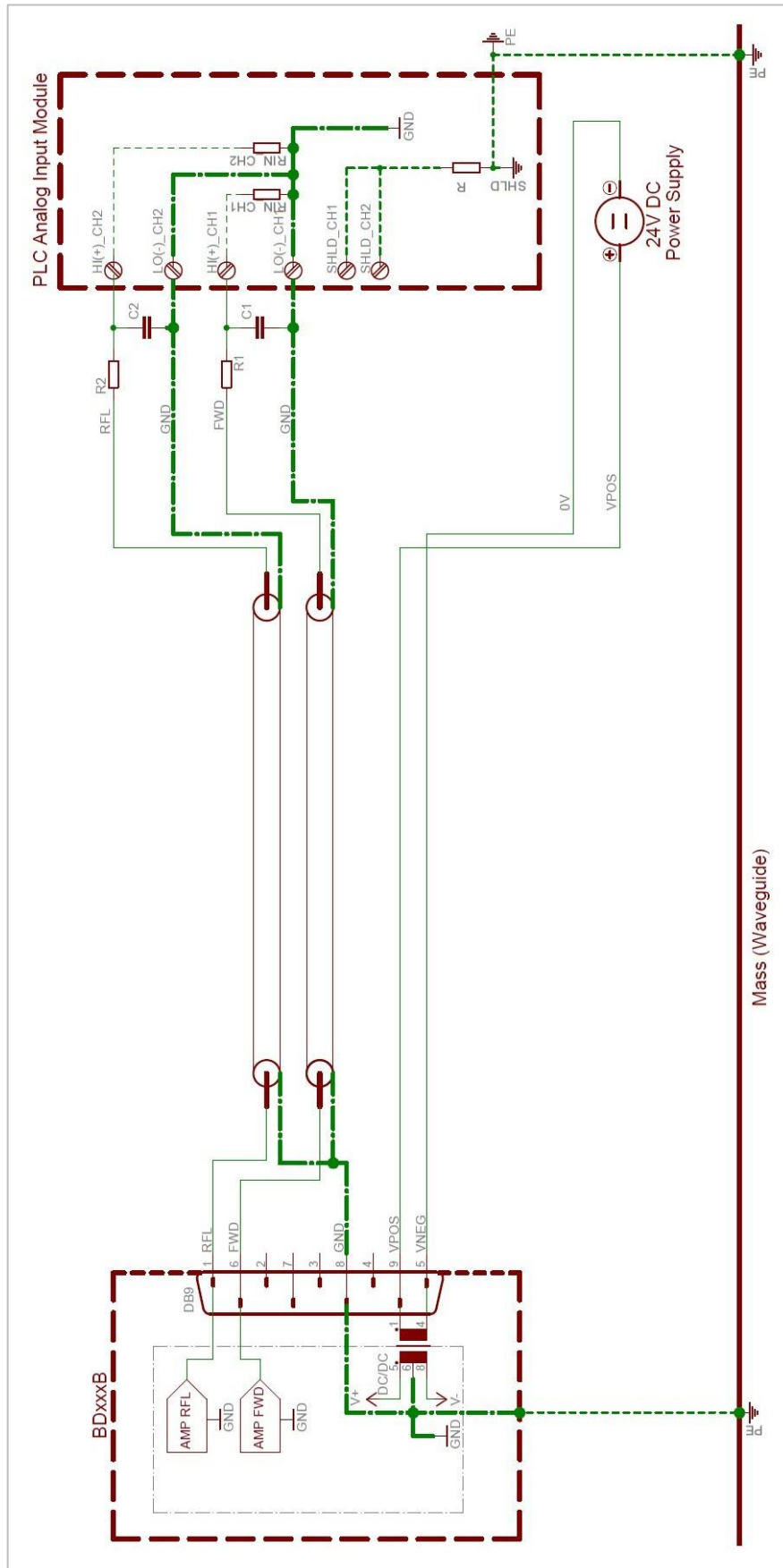

Fig. 8. Example of BDxxxB – PLC connection.

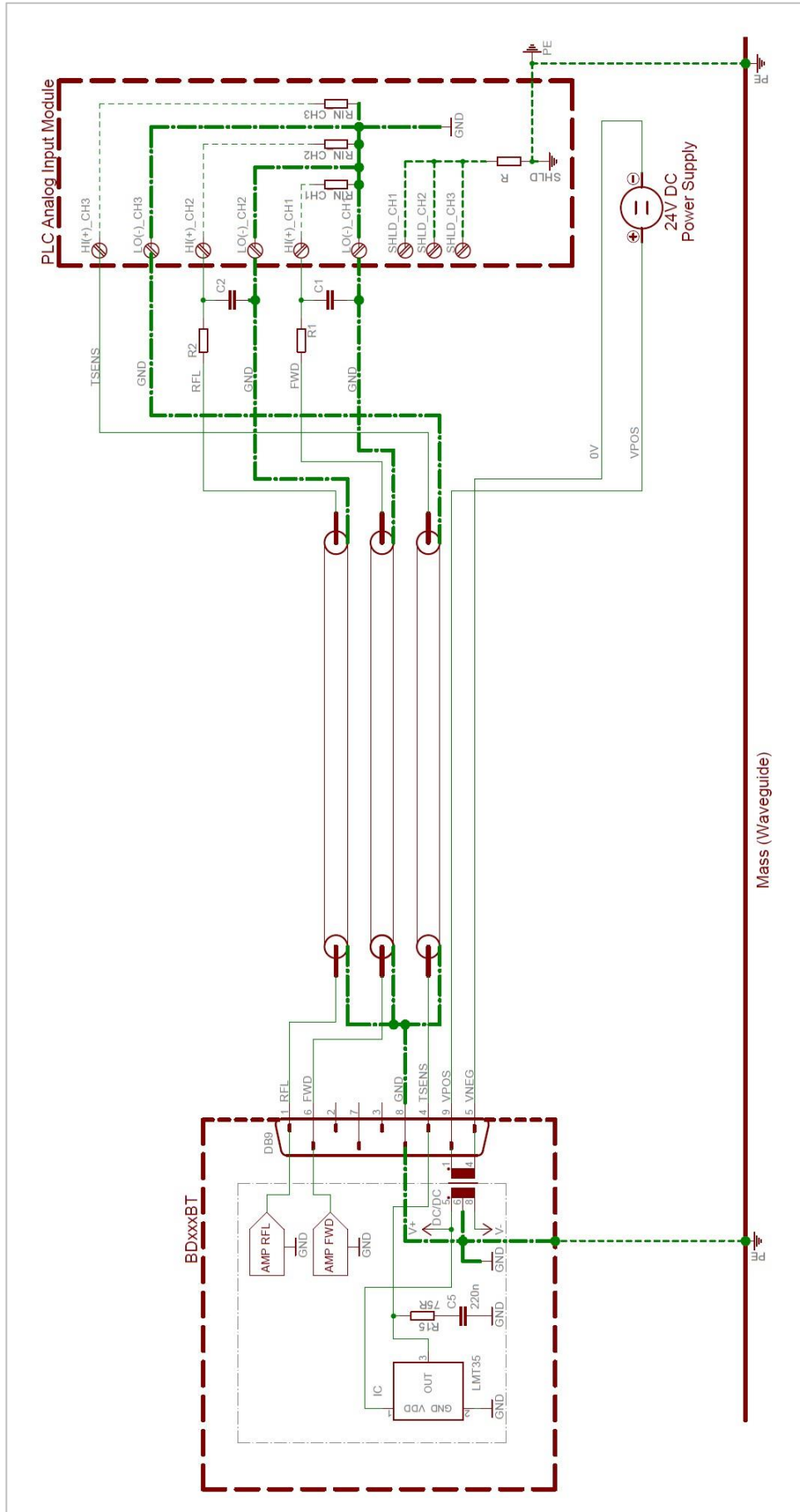

Fig. 9. Example of BDxxxBT – PLC connection.

Time Constant

The internal output time constant of BD132B is set to approximately 150 μs (3-dB cutoff frequency of about 1 kHz). To improve interference immunity in CW applications, the time constant can be increased by an optional external RC filter as indicated in the wiring diagram (R1, C1 and R2, C2). The filters, if applied, should be placed as close to the PLC inputs as possible.