

DC114: Directional Coupler for R26 Waveguide

Description

DC114 is a small-housing directional coupler intended for sampling incident or reflected waves in high-power 2450 MHz industrial applications using an R26 (WR340) rectangular waveguide. The coupler is fixed to the waveguide with six M3 or similar-diameter screws after machining of appropriate holes in the broad waveguide wall. Simply reversing the coupler causes it to sample the wave propagating in the opposite direction.



Specifications

Frequency range	2425 – 2475 MHz
Coupling factor	-50 dB \pm 1dB -60 dB \pm 1 dB (default) -70 dB \pm 1dB
Directivity	25 dB min
Output connector	Nf (SMAf available upon request)
VSWR (N, SMA)	1.25 max
Waveguide of destination	R26 (86.36 mm x 43.18 mm, wall thickness 2 mm)

Dimensional drawing - N type connector (all units in millimeters)

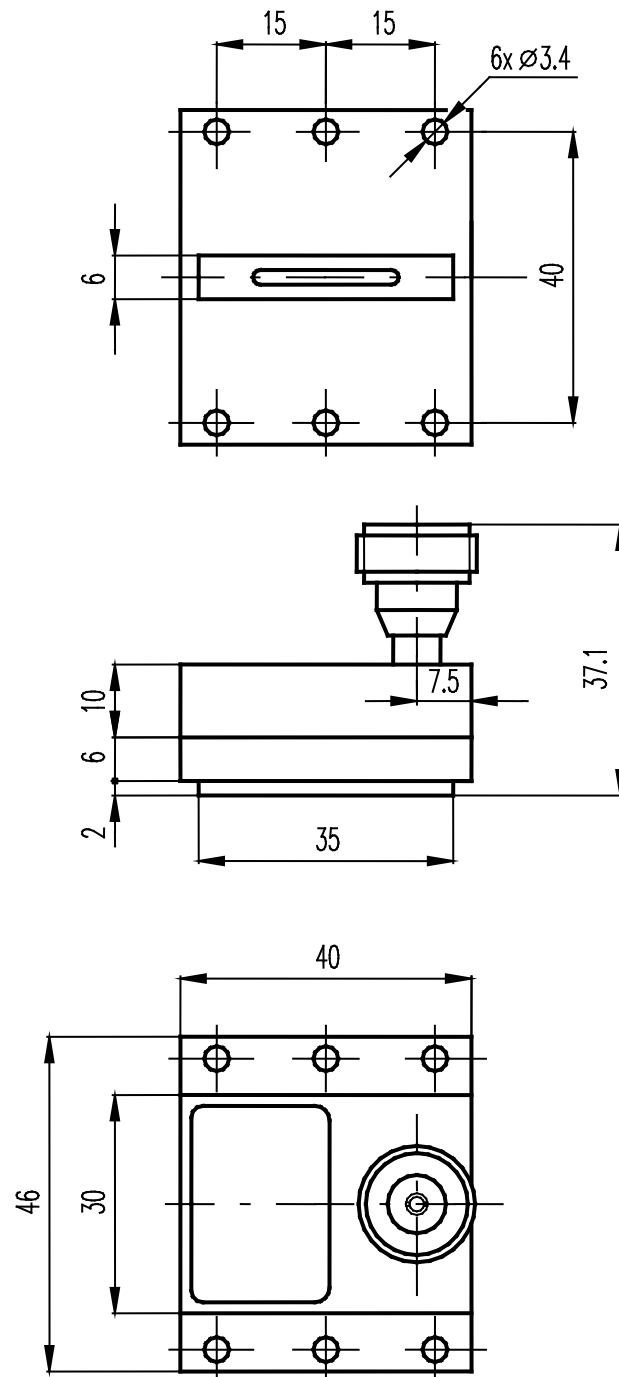

Dimensional drawing - SMA type connector (all units in millimeters)

